

Croso International GmbH  
Sophienhammer 12  
59757 Arnsberg

Datum

Ganzglas-Systemgeländer  
*Sägeschnittvarianten Bodenprofil 2.0 vorgesetzt*  
*SET 7, SET 8*

Angebotsanfrage

Bestellung

Kunde:

Bauvorhaben:

Projektstart:

Anmerkung:

Kunde:

Bauvorhaben:

2.3.1

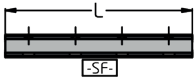

Profilbeschreibung				
Länge L [mm]				
Anzahl [Stück]				

**Gehrungsschnitte**

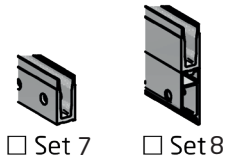
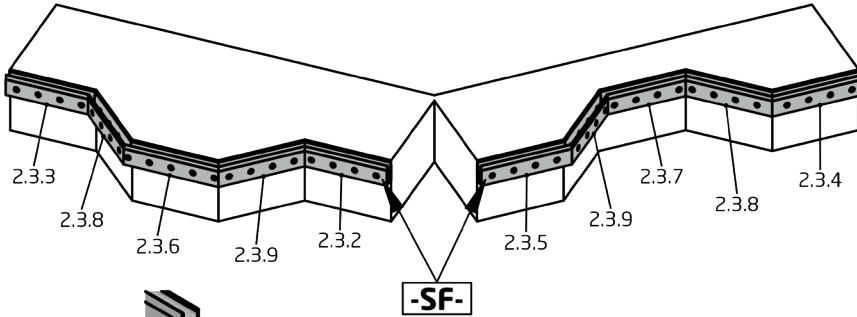

Sonderzuschnitte auf Anfrage

Bei Kombinationen aus Bodenprofil mit Unterbauprofil und/oder Abdeckprofil:  
Maßangaben "L, L1, a, b" gelten für den kompletten Zusammenbau  
(Bodenprofil inkl. Unterbauprofil und Abdeckprofil)

SF = Sichtfläche Profil

Profilbeschreibung = vom Kunden gewünschte Beschriftung auf dem Profil

2.3.3

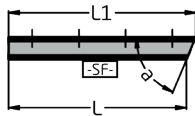

Profilbeschreibung				
Länge L [mm]				
Länge L1 [mm]				
Winkel a [°]				
Anzahl [Stück]				

2.3.8

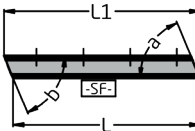

Profilbeschreibung				
Länge L [mm]				
Länge L1 [mm]				
Winkel a [°]				
Winkel b [°]				
Anzahl [Stück]				

2.3.6

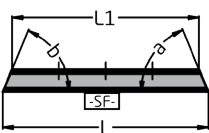

Profilbeschreibung				
Länge L [mm]				
Länge L1 [mm]				
Winkel a [°]				
Winkel b [°]				
Anzahl [Stück]				

2.3.9

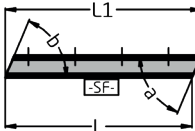

Profilbeschreibung				
Länge L [mm]				
Länge L1 [mm]				
Winkel a [°]				
Winkel b [°]				
Anzahl [Stück]				

2.3.2

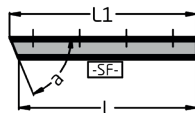

Profilbeschreibung				
Länge L [mm]				
Länge L1 [mm]				
Winkel a [°]				
Anzahl [Stück]				

2.3.5

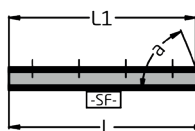

Profilbeschreibung				
Länge L [mm]				
Länge L1 [mm]				
Winkel a [°]				
Anzahl [Stück]				

2.3.7

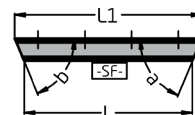

Profilbeschreibung				
Länge L [mm]				
Länge L1 [mm]				
Winkel a [°]				
Winkel b [°]				
Anzahl [Stück]				

2.3.4

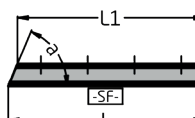

Profilbeschreibung				
Länge L [mm]				
Länge L1 [mm]				
Winkel a [°]				
Anzahl [Stück]				

Kunde:

Bauvorhaben:

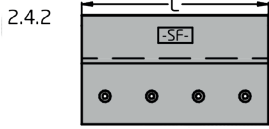
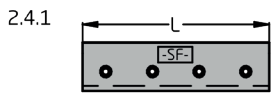

Profilbeschreibung				
Länge L [mm]				
Anzahl [Stück]				

**Gehrungsschnitte**

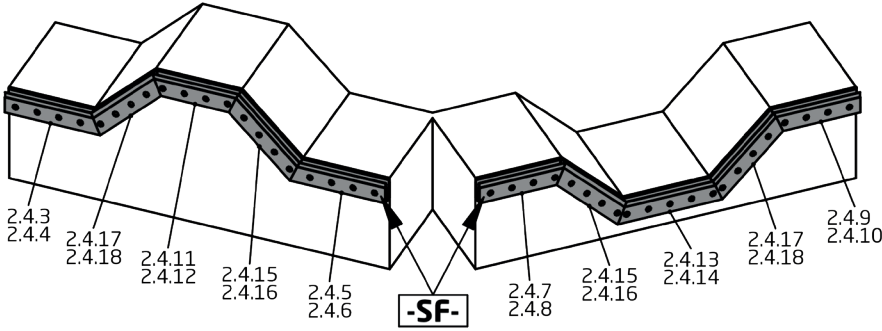

Sonderzuschnitte auf Anfrage

Bei Kombinationen aus Bodenprofil mit Unterbauprofil und/oder Abdeckprofil:  
Maßangaben "L, L1, a, b" gelten für den kompletten Zusammenbau  
(Bodenprofil inkl. Unterbauprofil und Abdeckprofil)

SF = Sichtfläche Profil

Profilbeschreibung = vom Kunden gewünschte Beschriftung auf dem Profil

□ Set 7



□ Set 8

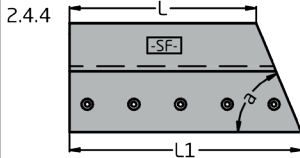
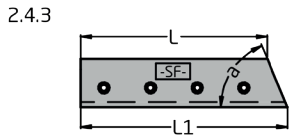

Profilbeschreibung				
Länge L [mm]				
Länge L1 [mm]				
Winkel a [°]				
Anzahl [Stück]				

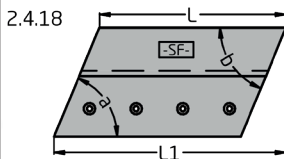
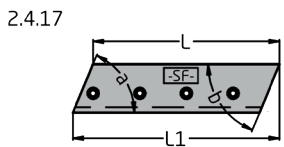

Profilbeschreibung				
Länge L [mm]				
Länge L1 [mm]				
Winkel a [°]				
Winkel b [°]				
Anzahl [Stück]				

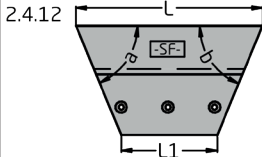
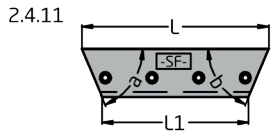

Profilbeschreibung				
Länge L [mm]				
Länge L1 [mm]				
Winkel a [°]				
Winkel b [°]				
Anzahl [Stück]				

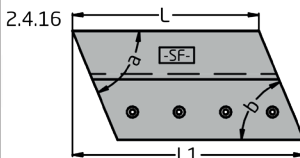
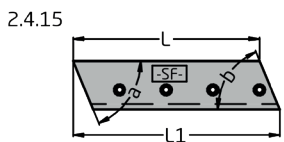

Profilbeschreibung				
Länge L [mm]				
Länge L1 [mm]				
Winkel a [°]				
Winkel b [°]				
Anzahl [Stück]				

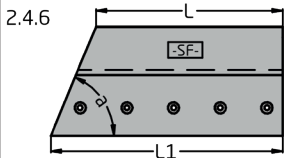
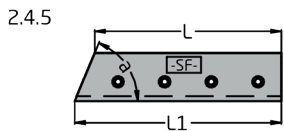

Profilbeschreibung				
Länge L [mm]				
Länge L1 [mm]				
Winkel a [°]				
Anzahl [Stück]				

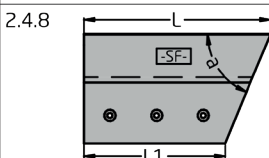
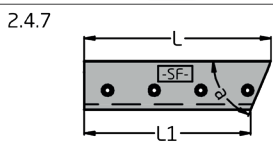

Profilbeschreibung				
Länge L [mm]				
Länge L1 [mm]				
Winkel a [°]				
Anzahl [Stück]				

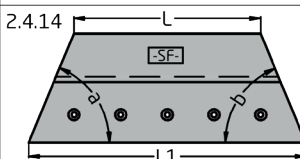
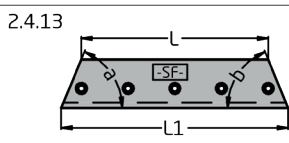

Profilbeschreibung				
Länge L [mm]				
Länge L1 [mm]				
Winkel a [°]				
Winkel b [°]				
Anzahl [Stück]				

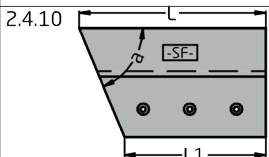
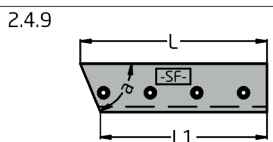

Profilbeschreibung				
Länge L [mm]				
Länge L1 [mm]				
Winkel a [°]				
Anzahl [Stück]				